

# Microcontroller accessories in mlab

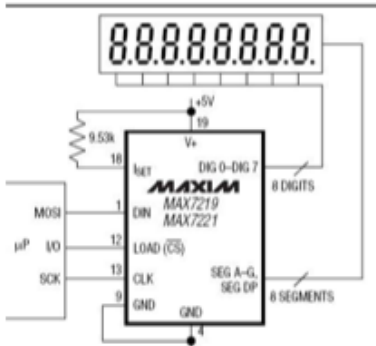

LED Display Driver



5x7 led matrix

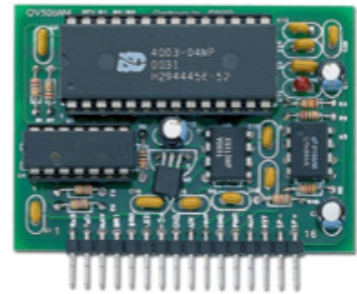

Audio Playback Module



Hall-Effect Sensor



Touch Sensor



Flexiforce Sensor

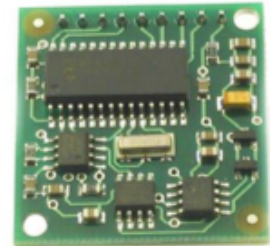

Compass module



Accelerometer



Bluetooth connectivity



stepper motor



IR detector



IR transmit and receive

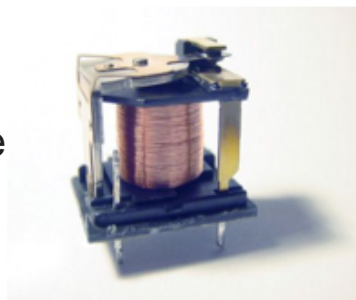

relay

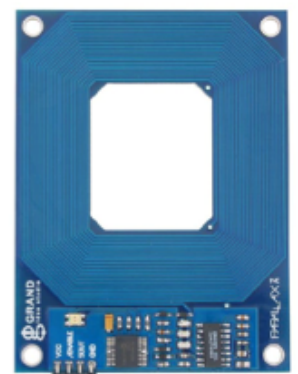

RFID Reader



Vibration sensor

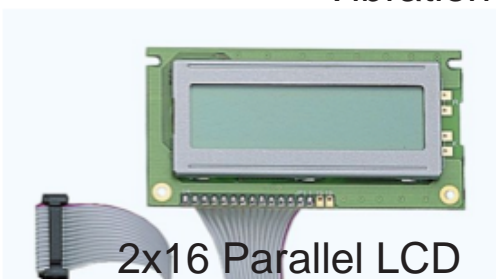

2x16 Parallel LCD

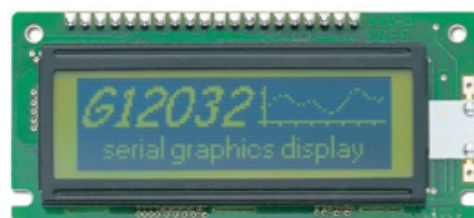

120 x 32 Graphic LCD